

ASISTENT AS-035-00

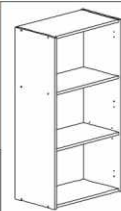



22300,00	21100,00	27000,00		35101,01
A 12x	C 24x	D 12x	F 12x	J 4x

0h 50min		4	5,5 x 125	≤ 0,5 kg	0,6m	3m	
----------	--	---	-----------	----------	------	----	--

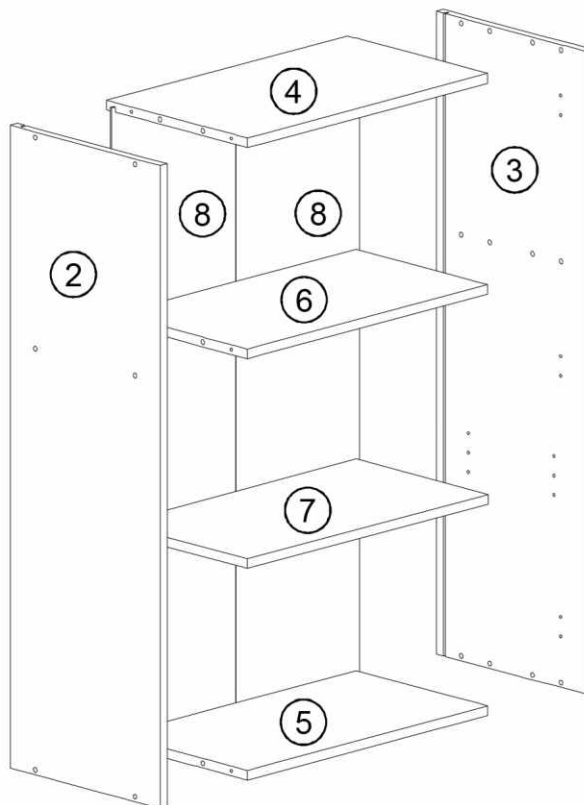

ID	ID	ID	ID	ID
00160	②	1059*336*16	1x	1/1
00161	③	1059*336*16	1x	1/1
00003	④	540*316*16	1x	1/1
00004	⑤	540*296*16	1x	1/1
00007	⑥	540*296*16	1x	1/1
00005	⑦	540*296*16	1x	1/1
00162	⑧	1048*278*2,5	2x	1/1



✓	✗	✗	✗	✗	✗ ✗
---	---	---	---	---	------

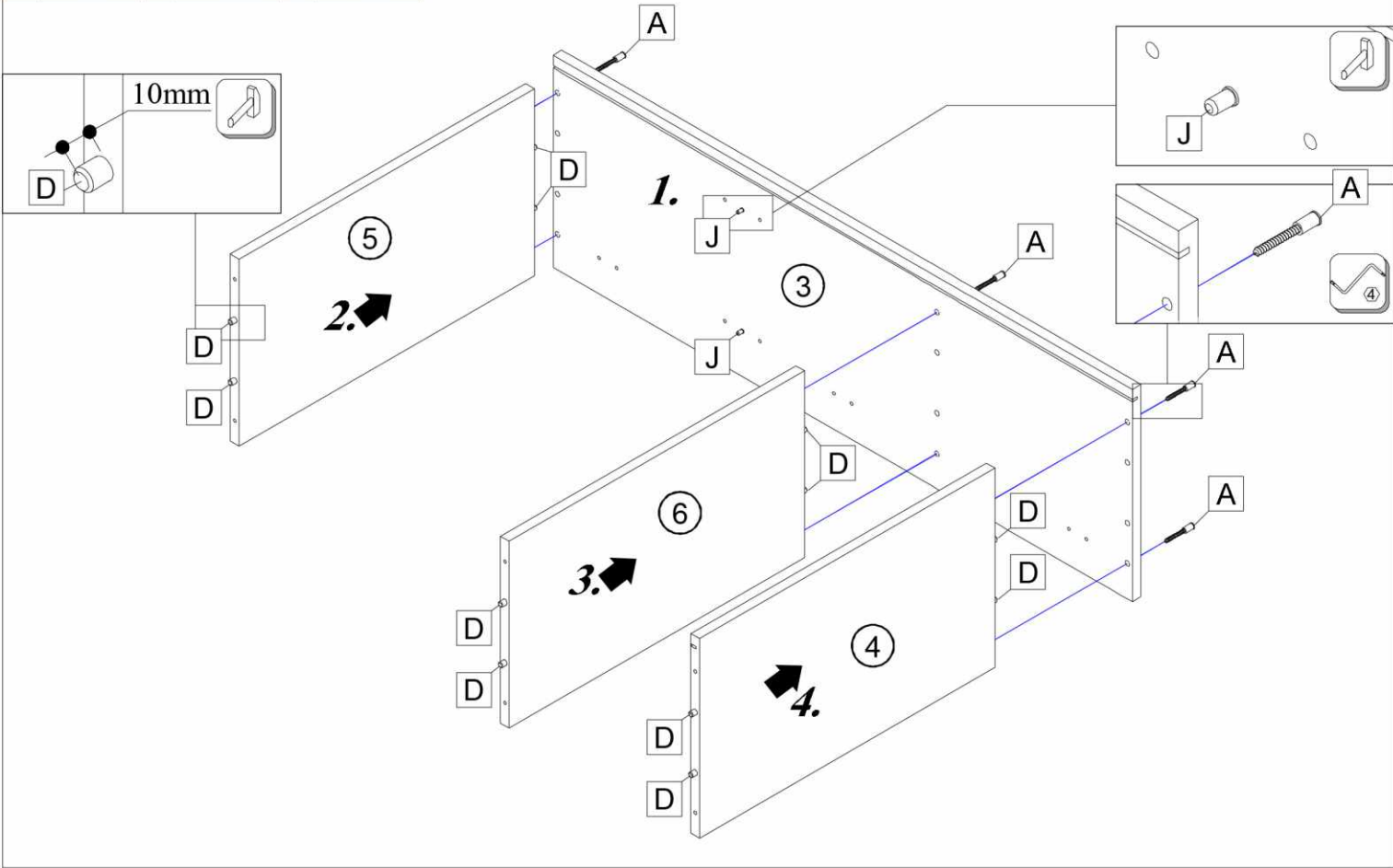

		
A 6x	D 12x	J 2x

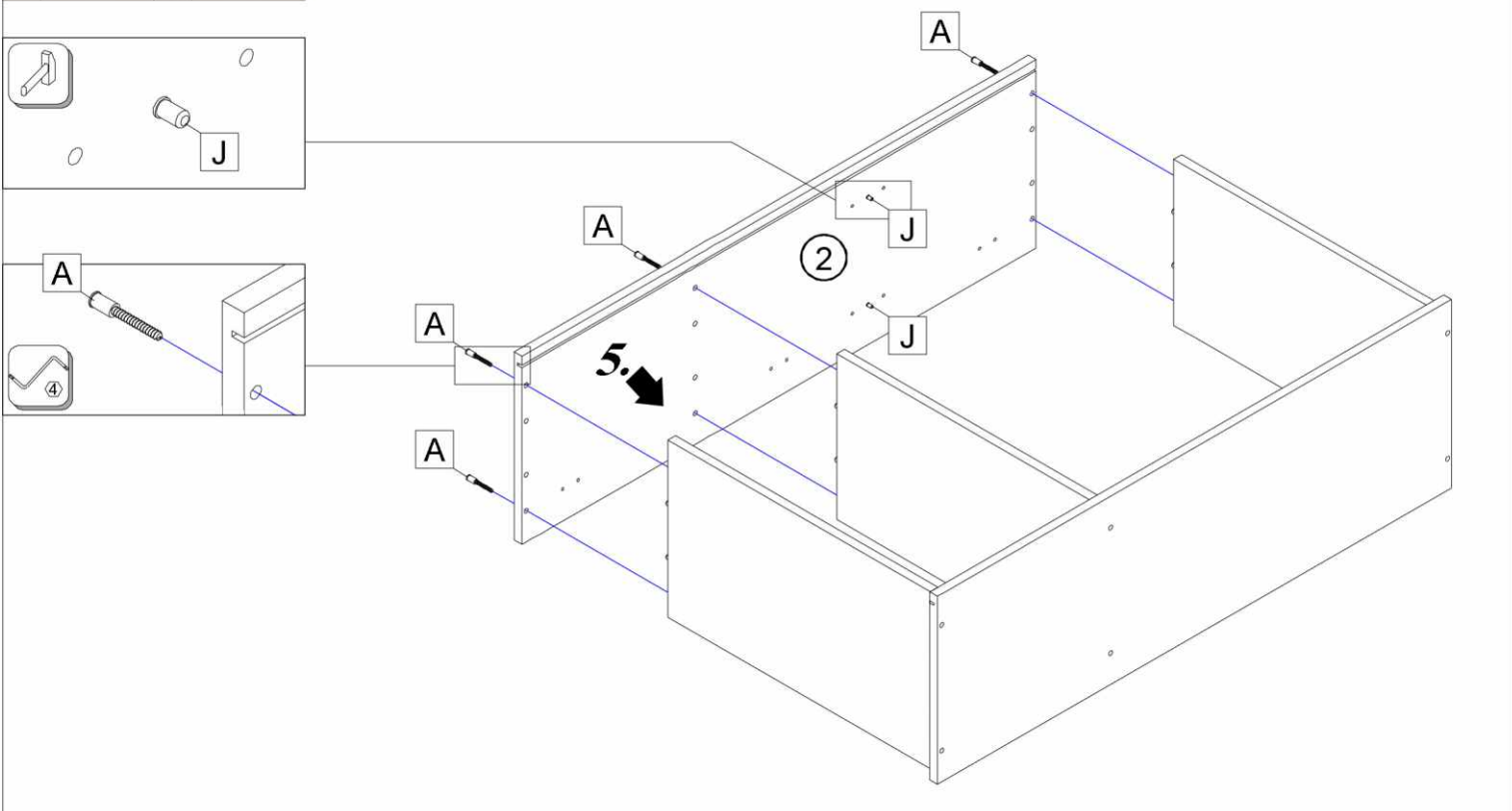

	
A 6x	J 2x

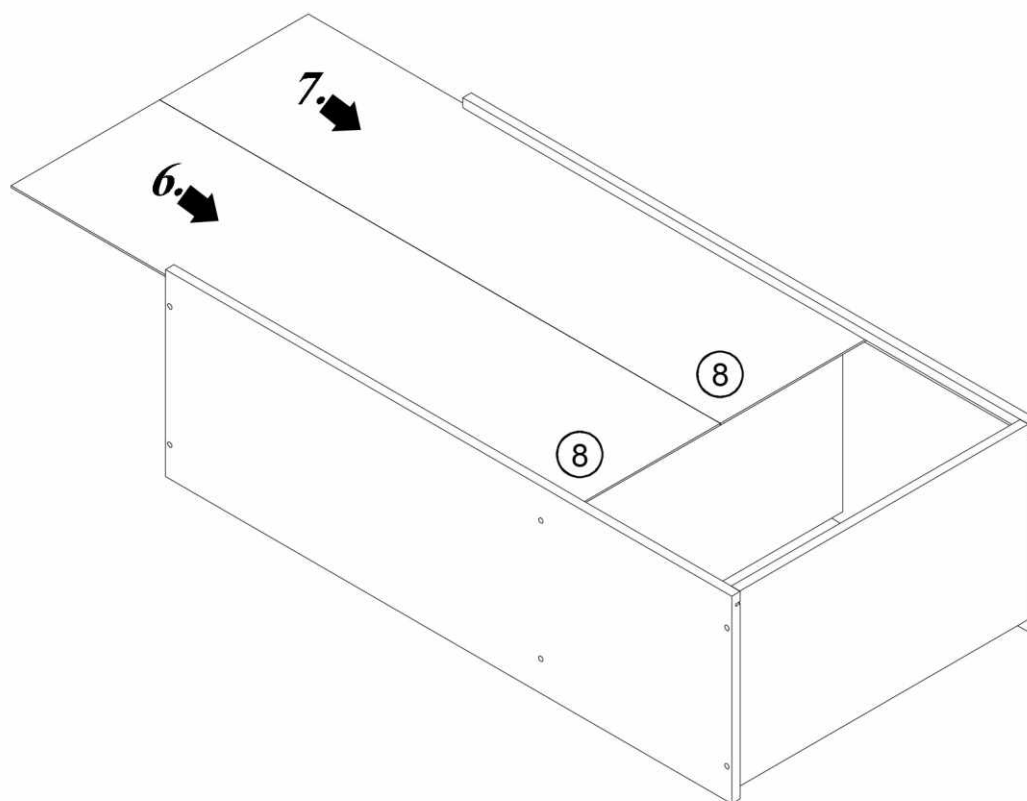



	$\varnothing 1,6 \times 20$	
C	24x	F
		12x

