

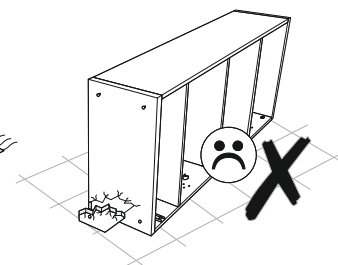

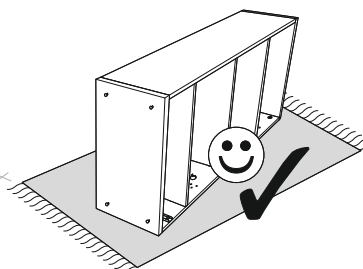

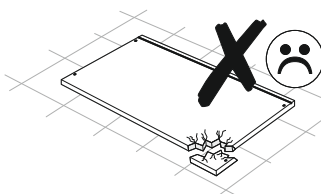

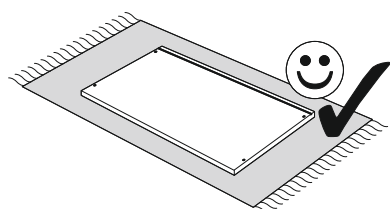
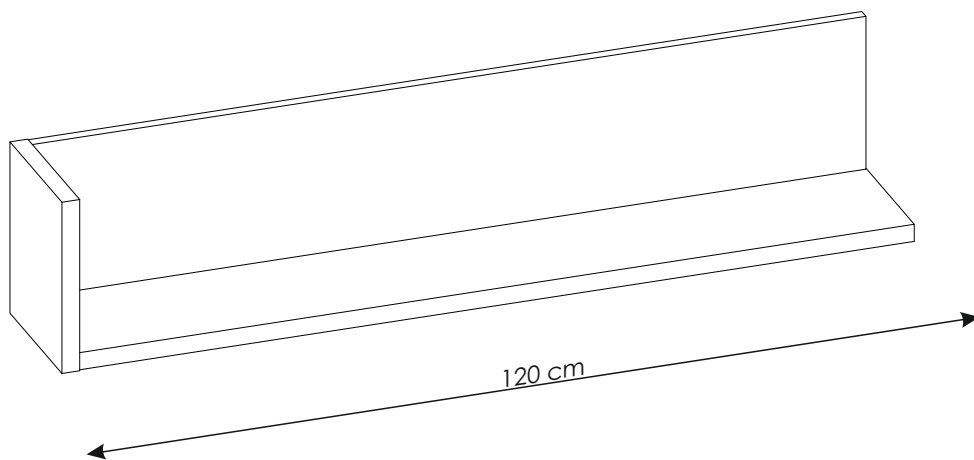
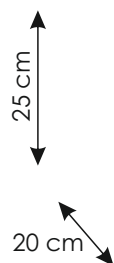
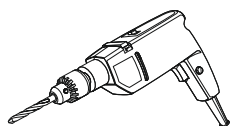
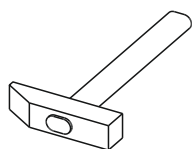
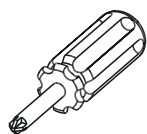
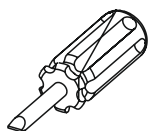
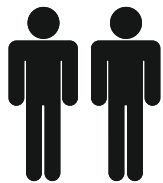
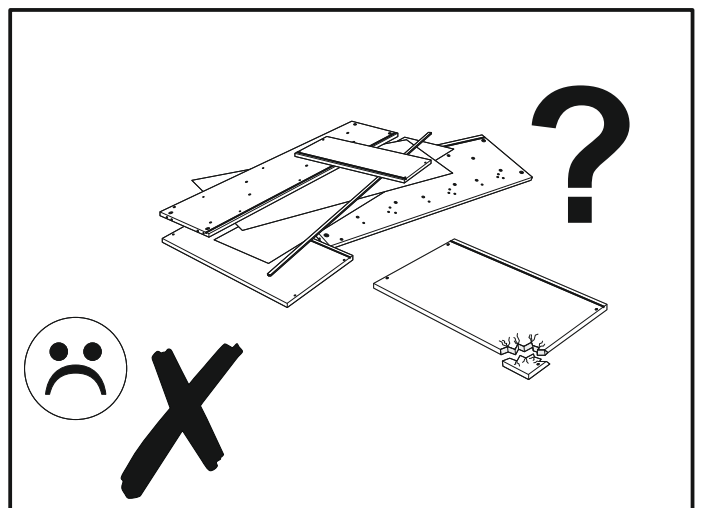
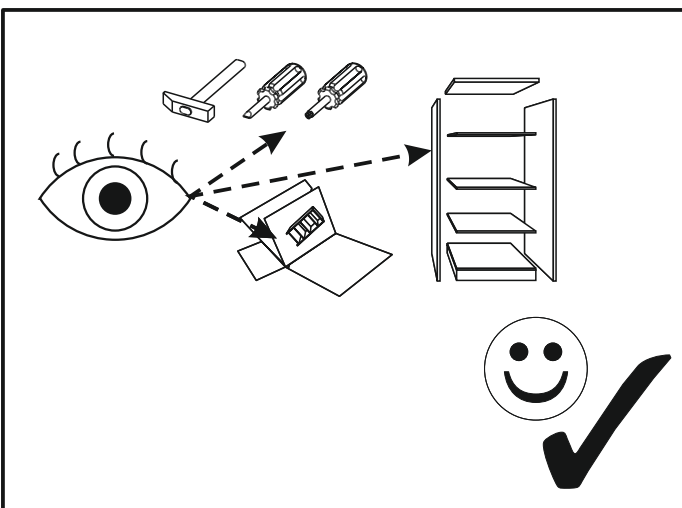
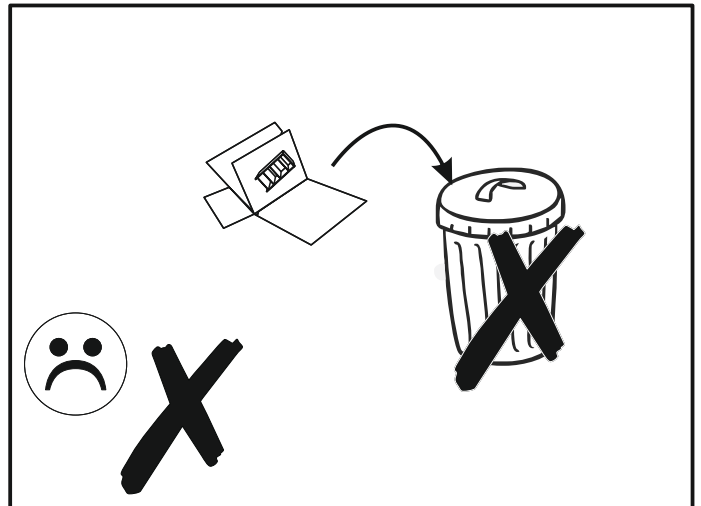
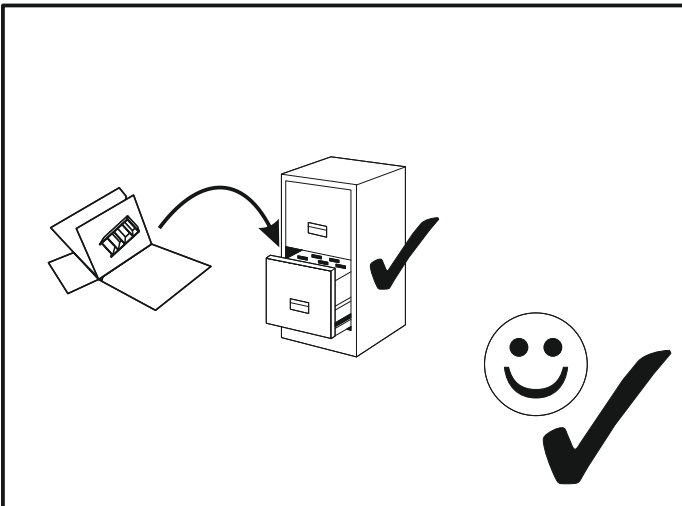
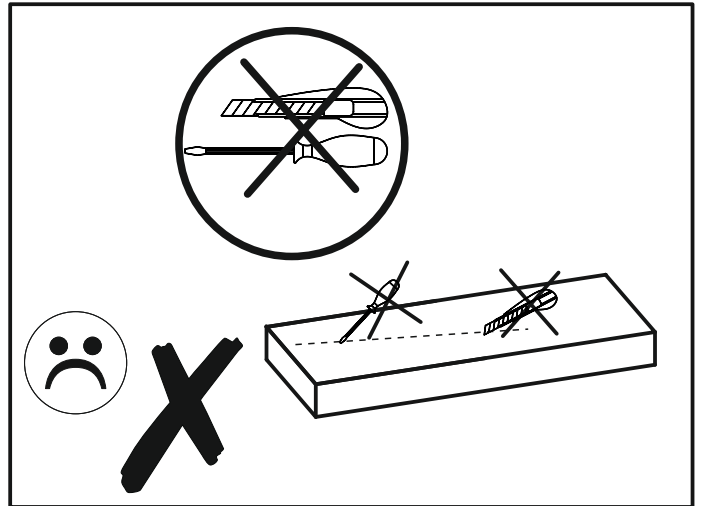
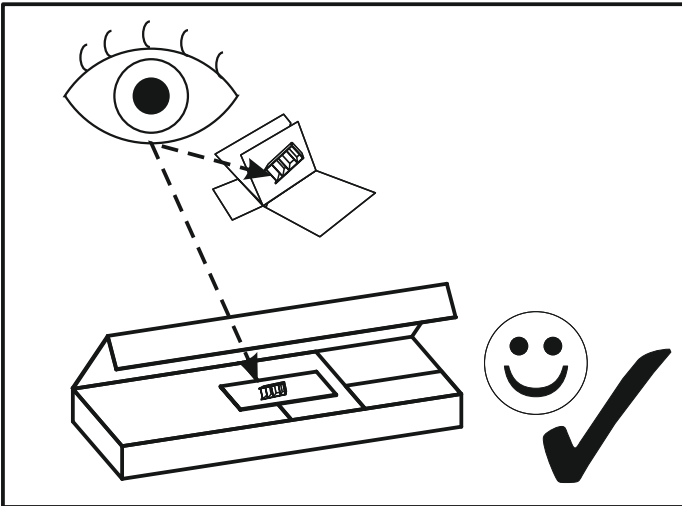

LEONARDO LYOP01





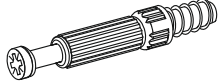
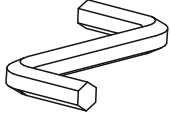

MM

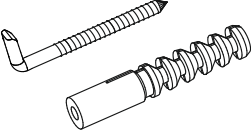
<p>A1 8 x 35 mm x8</p> 	<p>C2 5 x 13 mm x4</p> 	<p>C4 6.3 x 13 mm x2</p> 
<p>E0 x8</p> 	<p>E1 15 x 12 mm x8</p> 	<p>F1 6 x 34 mm x8</p> 
<p>M x1</p> 	<p>P1 x2</p> 	<p>R8 x2</p> 
<p>S14 x2</p> 		

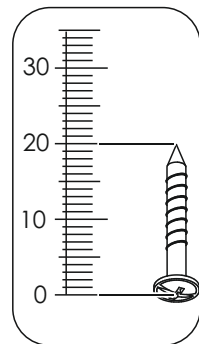
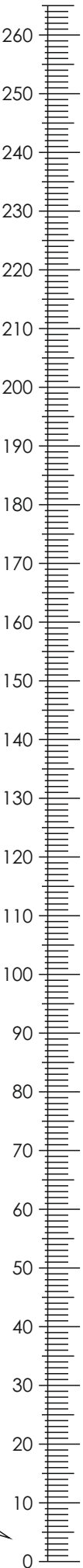

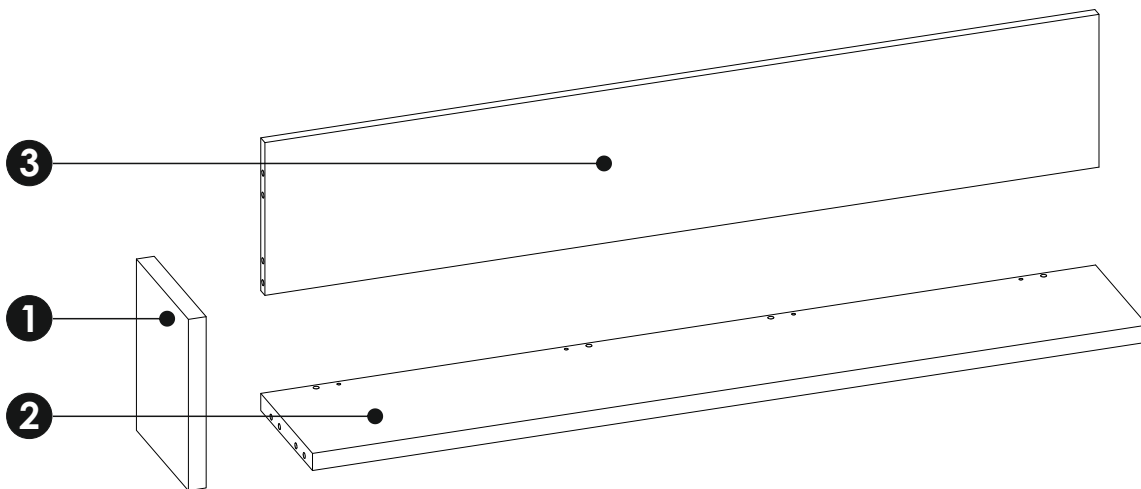
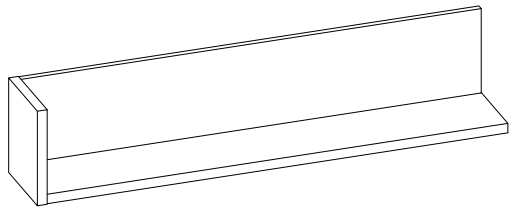

1	250	201	25 x1	1/1
2	1175	200	25 x1	1/1
3	1174	223	16 x1	1/1

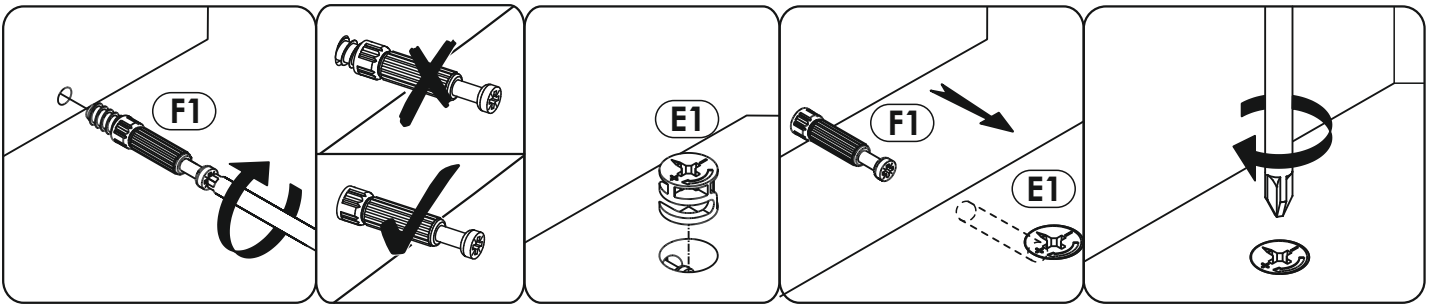

1 ▶

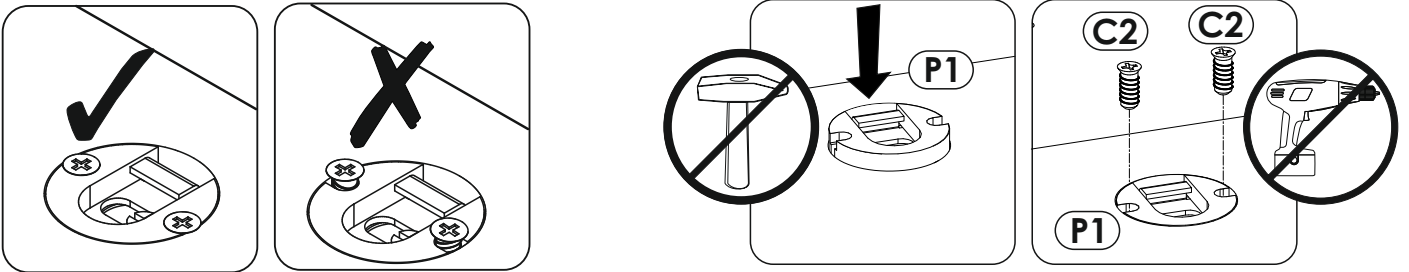
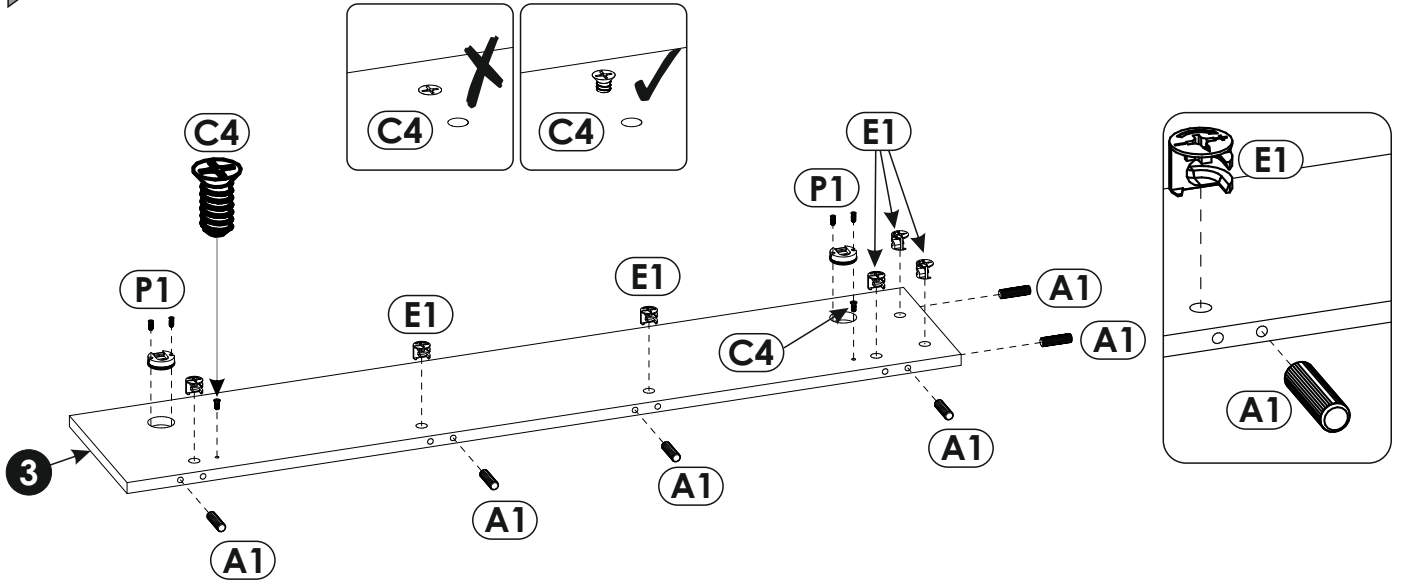

2 ▶

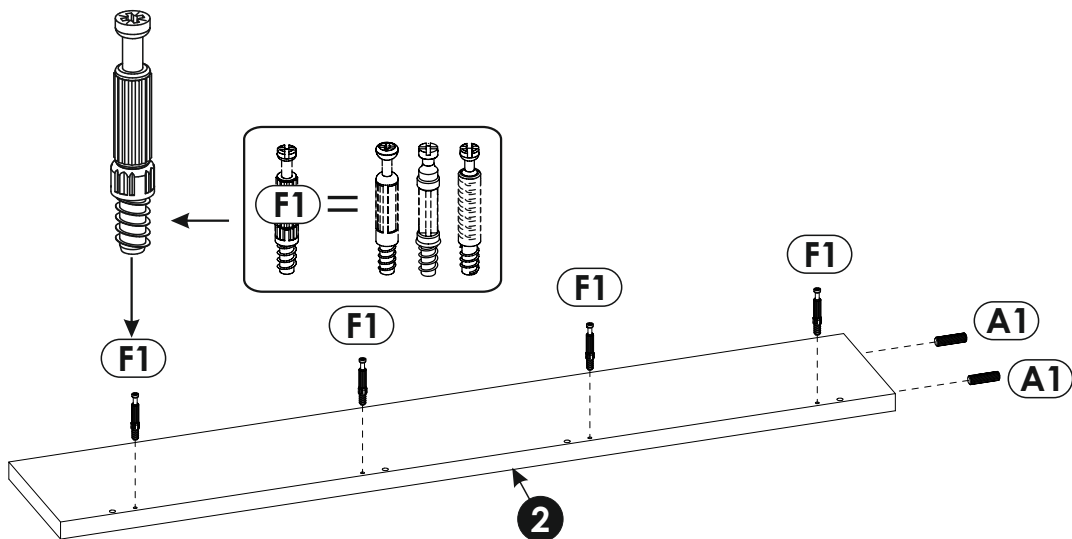

3 ▶

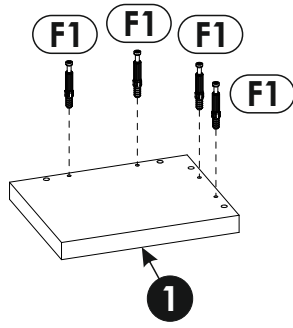

4 ▶

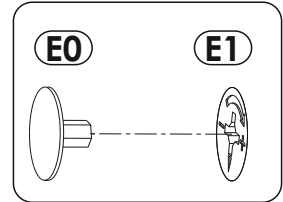
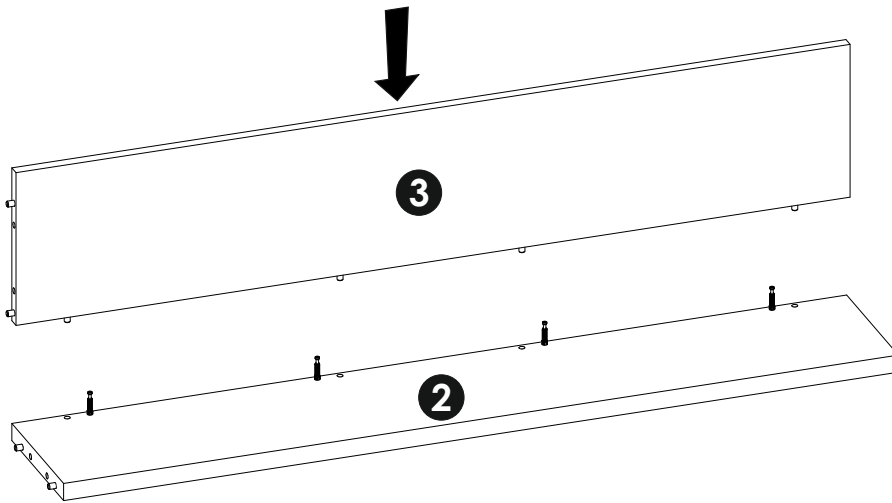

5 ▶

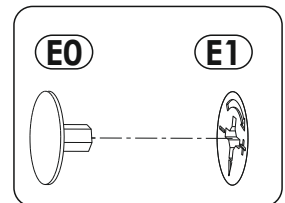
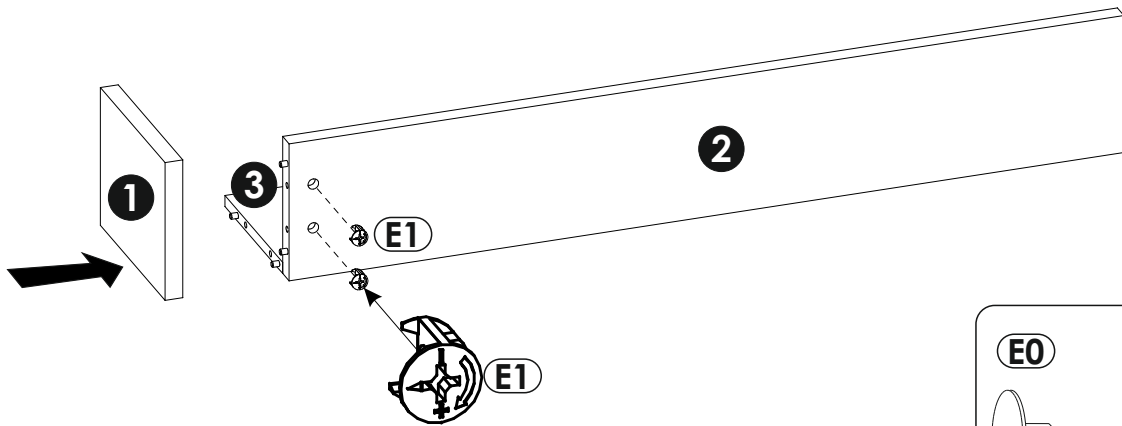

6 ▶

