

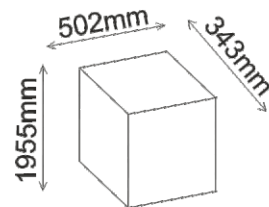

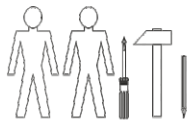

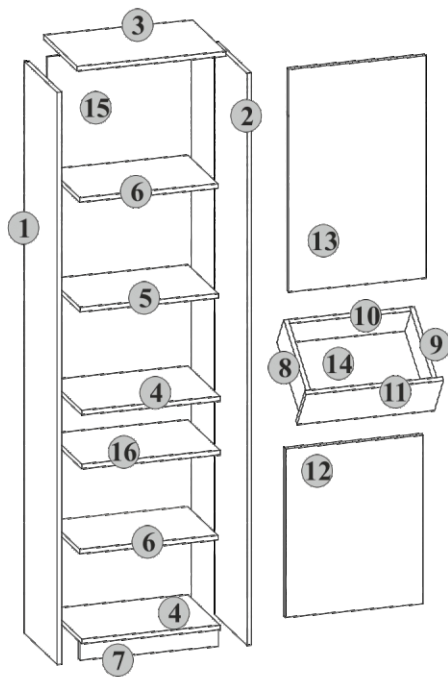













# TEYO 2D1S



4x  k1	8x  φ6.3x13 mm e2	1x  w300	1x  GLUE y1	3x  c114	22x  φ15 #16 r1
9x  φ5x17 mm d1	22x  r16	4x  a2	6x  p78	50x  1x16 l1	1x  z1
20x  φ3.5x13 mm p1	22x  s2	4x  b1	32x  φ6x30 mm f1	2x  7x50 e1	2x  s1

