

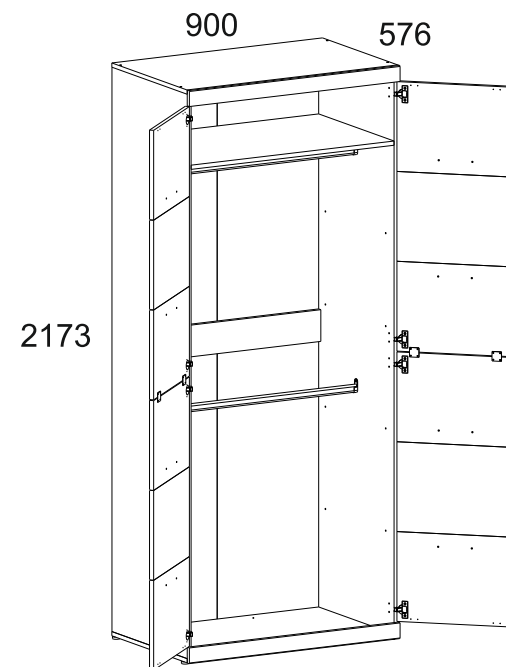

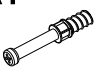







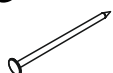

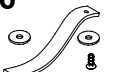

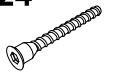
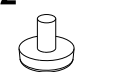
# MONTÁŽNY NÁVOD

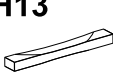
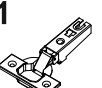

<b>A1</b>  14	<b>A2</b>  14	<b>G</b>  1.5x26 52
<b>B5</b>  1	<b>S5</b>  7	<b>S6</b>  1
<b>C1</b>  8x35 18	<b>R24</b>  7x50 8	<b>N2</b>  6
<b>Q</b>  4	<b>I</b>  1	<b>H13</b>  2
<b>E1</b>  8	<b>Ri2</b>  3,5x16 30	<b>R32</b>  4x27 4
<b>D1</b>  8	<b>U5</b>  4	<b>Y1</b>  4
<b>R23</b>  6,3x13 16	<b>R28</b>  2,5x13 16	<b>Q3</b>  1

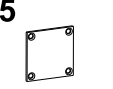
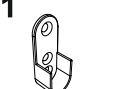
II

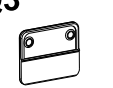
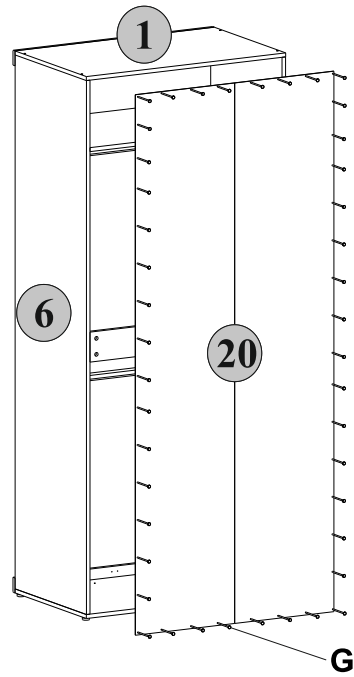

I

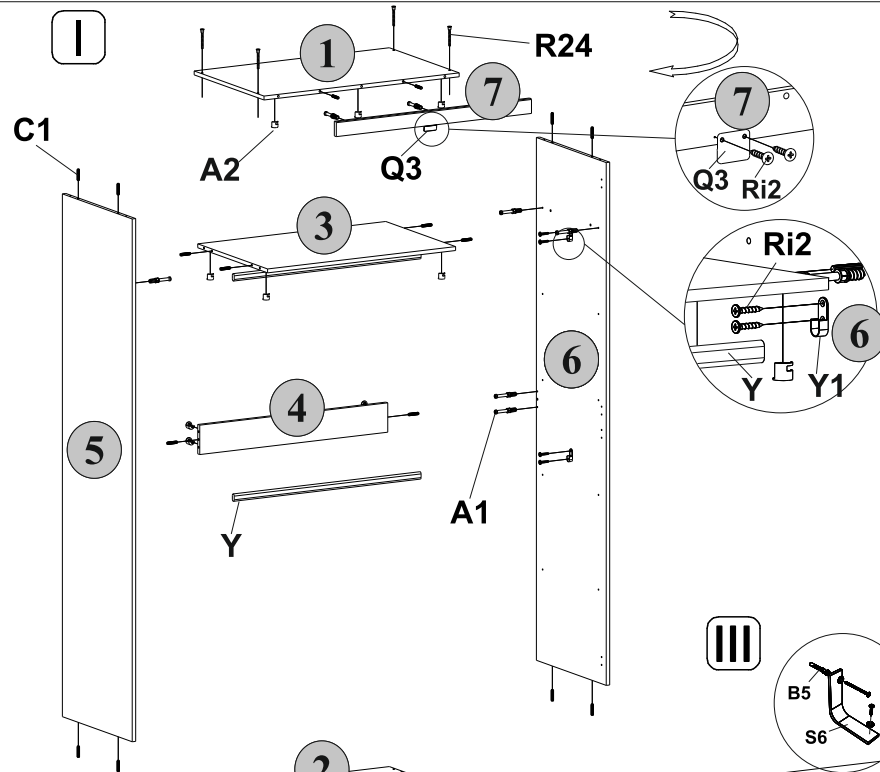

III

